

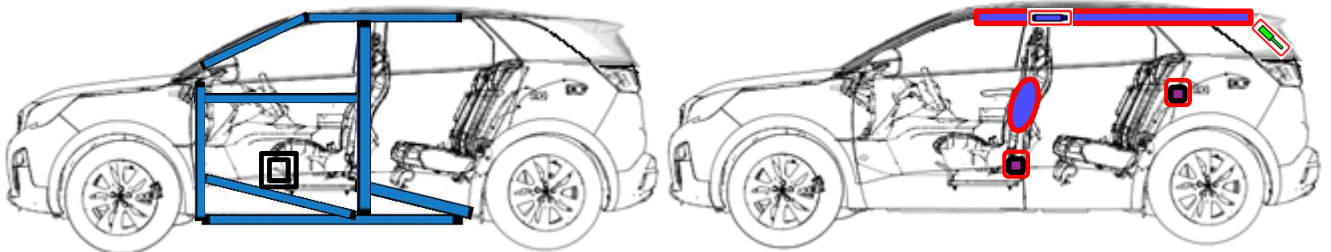

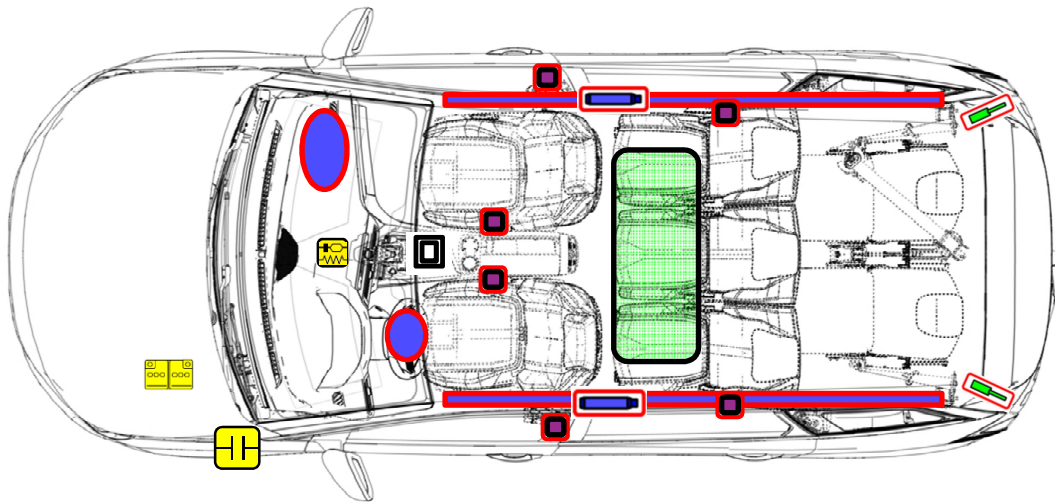







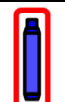









Peugeot 5008 (ab März 2017)



	Airbag		Gasgenerator		Gurtstraffer		SRS-Steuergerät		Automatisches Überrollschutzsystem
	Aktives Fußgängerschutzsystem		Gasfeder, vorgespannte Feder		Hochfester Bereich		Bereich, der besondere Aufmerksamkeit erfordert		
	Niederspannungsbatterie		Niederspannungs-Ultrakondensator		Kraftstofftank		Gastank		Sicherheits-hahn
	Hochspannungsbatterie		Hochspannungskabel/-komponente		Hochspannung-Nottrennschalter		Kasten mit Hochspannungssicherungen		Hochspannungs-Ultrakondensator

Marke	Modell	Phase	Jahr der Modell-einführung	Interne Teilenummer	Datum der Erstellung	Datum der Aktualisierung	Version Nr.
Peugeot	5008	2	2017	01365_17_00009	10/01/2017	OR	1



Besonderheiten

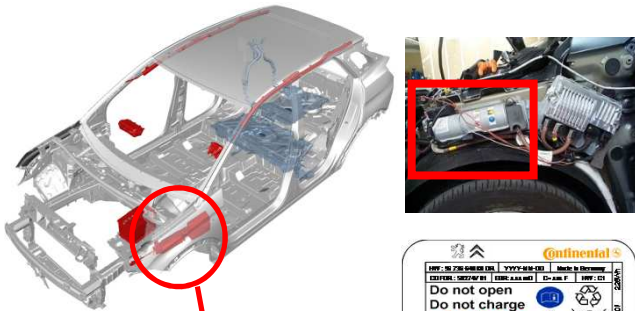

1/ STOP & START-System:

Dieselmotorenmodell „e-HDi“ mit zusätzlicher Kapazität (E-Booster), die Acetonitril enthält.

Moteurs essence	1,2 PureTech 130 S&S	1,6 THP 165 S&S	
Moteurs Diesel	1,6 BlueHDi 100 S&S	1,6 BlueHDi 115 S&S 120 S&S	2,0 BlueHDi 150 S&S 180 S&S

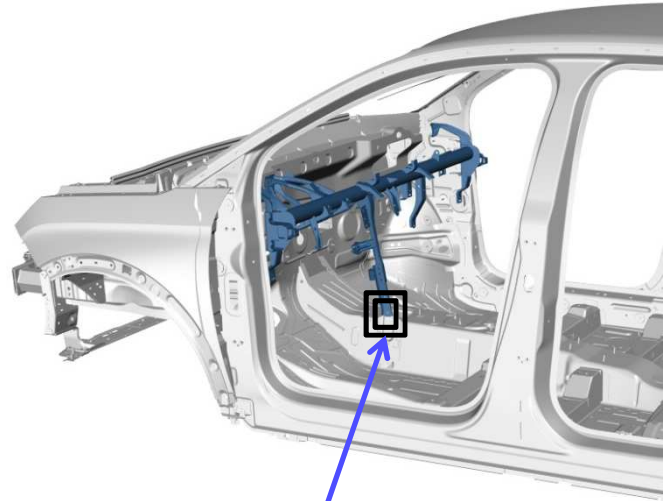

2/ Abstützung: unter der Mittelkonsole; diese Stütze muss zum Wegklappen des Frontmoduls durchtrennt werden.

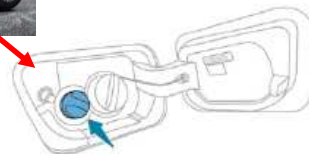

3/ AdBlue (17 l) :

Bei AdBlue handelt es sich um eine Urea-Lösung. Diese Flüssigkeit ist **unentzündlich**, farblos und geruchslos. Im Brandfall kann Ammoniak austreten (reizend für Augen, Nase und Rachen)

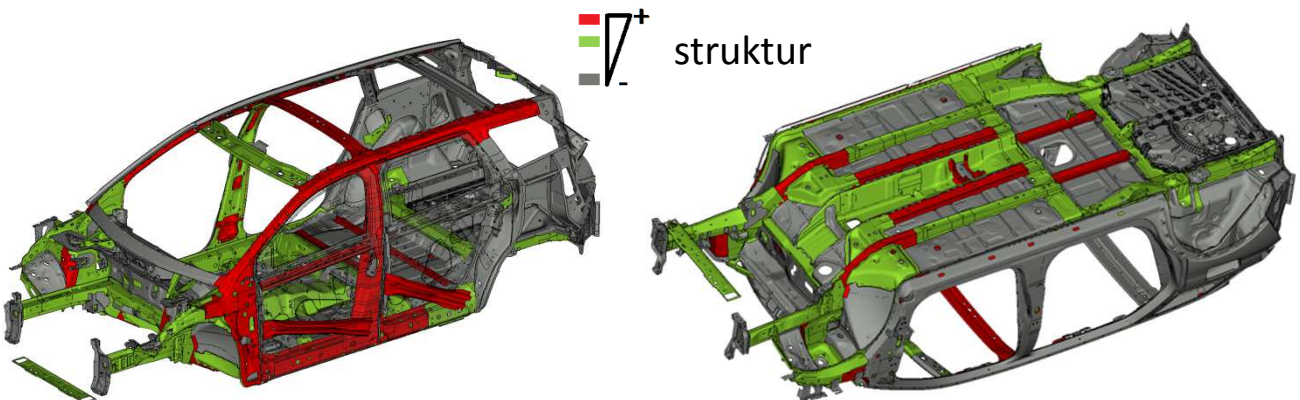

Marke	Modell	Phase	Jahr der Modell-einführung	Interne Teilenummer	Datum der Erstellung	Datum der Aktualisierung	Version Nr.
Peugeot	5008	2	2017	01365_17_00009	10/01/2017	OR	1